









Key	Component	Qty
	A Bleeding Valve Key	1
	B Bleeding Valve 1/2 "	1
	C Blind Tap	1
	D Friction Cups/Cushions	4
	E Left Bracket	2
	F Right Bracket	2
	G Screw-5,5x45mm	8
	H Wall Plug	8



### Assembly Instructions

Fit bleeding valve (B) & blind tap (C).

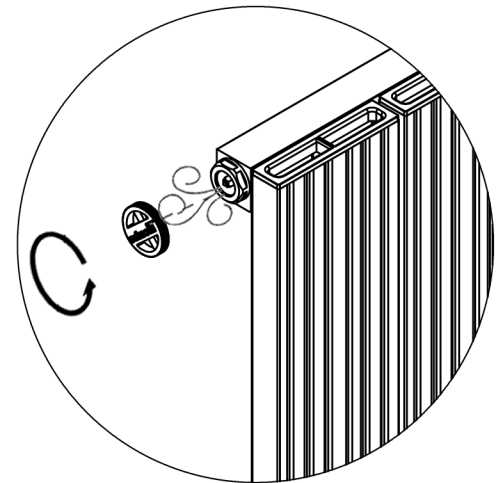
Use Carisa bleeding valve key (A) to turn bleeding valve (B).

Accurately mark out bracket holes on wall using spirit level.

Drill four 8mm diameter holes for upper brackets (E) and four 8mm diameter holes for bottom brackets (F).

Friction cups (D) **MUST** be fitted to each mounting brackets (E,F) to suppress potential noise.

Screw brackets (E,F) into wall plugs (H) with 5,5mm diameter x 45mm screws (G).

Hang radiator by sliding the bosses on the back of the radiator into brackets (E,F).